

COLLEGE STATION I.S.D.  
9304 ROCK PRAIRIE ROAD COLLEGE STATION, TX. 77845  
(979) 764-5408

**PURCHASING OFFICE**

**INTER-DEPARTMENTAL MEMO**

TO: Mike Martindale  
DATE: April 8, 2020  
SUBJECT: Furniture for A&M Middle Remodeling

As part of the 2017 bond program, the Principal at A&M Middle has identified furniture for the summer 2020 renovation of the classrooms, cafeteria, and offices. The attached quotes from Educator's Depot Inc. is a result of several planning meetings with representatives from the district and the vendor.

The pricing proposed by Educator's Depot Inc. is per the Texas Local Government Statewide Purchasing Cooperative Buy Board Contract #584-19 Furniture. This cooperative is administered by TASB and all items included in this contract have been competitively bid and awarded by the Cooperative's Board of Trustees based on state statutes.

It is the recommendation of Carmella Shafer, Director of Purchasing and Omar Espitia, Principal at A&M Middle to purchase the furniture, installation, and debris removal from Educator's Depot Inc. delivered and installed for \$328,640.98 per Buy Board Contract #584-19 using 2017 bond funds.



Carmella Shafer, Director of Purchasing



Omar Espitia, Principal

**Proposal**  
for  
**College Station ISD - AMCMS Classroom and Office Update for Omar Espitia  
Option 2 per BuyBoard R3**

*A&M Consolidated Middle School  
105 Holik  
College Station, TX  
77840*

*(979) 764-5406*

**Prepared By:**



**Educator's Depot Inc.**

**Ariel Wehling**







**Proposal**





**Educator's Depot Inc.**  
 17424 W. Grand Pkwy. S. Suite 206  
 Sugar Land, TX  
 77479  
 Ph:1-866-736-2012  
 Fax:1-866-736-2014  
 www.educatorsdepot.com

Project ID: EDI007981  
 Project Name: College Station ISD - AMCMS Classroom and  
 Office Update for Omar Espitia Option 2 per  
 BuyBoard R3  
 Date: 04-13-2020  
 Rev. Level:  
 Prepared By: Ariel Wehling

**Room #: Classroom Furniture**



#	Qty	Prod#	Manufacturer	Name	Price	Ext. Price
1.	80	EDI000421	000101	Steel Bookcase 34 1/2"W x 12 5/8"D x 71"H, 5-Shelf; Color: Black	\$248.75	\$19,900.00
						
2.	45	EDI019700	000101	SOLVE TASK MID BACK MESH BACK. Mesh: TBD Fabric: TBD	\$226.44	\$10,189.80
						
3.	45	EDI013568	000101	Double Pedestal Desk 60"W x 30"D x 29 1/2"H; Laminate: TBD	\$667.56	\$30,040.20
						
4.	45	EDI010679	000101	Hon H1522 Laminate Center Drawer	\$117.40	\$5,283.00
						
5.	80	EDI005666	000101	4 Drawer Vertical File, Letter Size, w/ Lock	\$264.61	\$21,168.80
						
6.	803	EDI020015	000187	4700 Series Triangular Desk, Solid Plastic Top w/ Powder Coated Frame and Chrome. Color: TBD	\$125.91	\$101,105.73
						

7.	823		EDI020016	000187	18"H Thrive Contemporary polypropylene ribless flexible shell, 14 GA chrome frame. Color: Black	\$54.83	\$45,125.09
8.	5		EDI014299	000101	BUILD RIBBON 30 X 54	\$305.77	\$1,528.85

---

Room Total: **\$234,341.47**

# Room #: 501A Counselor Office

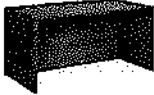
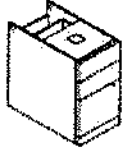





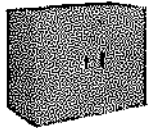

		Desc: -			Qty: 4	
#	Qty	Prod#	Manufacturer	Name	Price	Ext. Price
1.	1	EDI019751	000101	10500 Return Right 42x24, Color: TBD	\$462.05	\$462.05
						
2.	1	EDI006057	000101	10500 Series Return, file/file, 42"W x 24"D x 29 1/2"H, Left	\$462.05	\$462.05
						
3.	2	EDI018704	000101	Desk Shell with Full Modesty Panel, 2 Grommets, 30"D X 60"L X 29.5"H, Laminate: Kingswood Walnut	\$339.15	\$678.30
						
4.	2	EDI016831	000101	15 5/8"W x 28 3/4"D x 28"H Box/Box/File Pedestal; Laminate: TBD	\$368.60	\$737.20
						

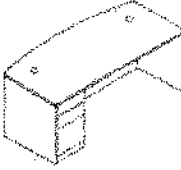

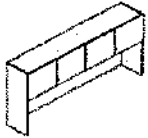
Room Total: **\$2,339.60**

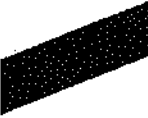
# Room #: 501B Counselor Office

		Desc: -			Qty: 2	
#	Qty	Prod#	Manufacturer	Name	Price	Ext. Price
1.	1	EDI004286	000101	10500 Series Credenza with Kneespace; 72W x 24D x 29.5H; Laminate: TBD	\$783.67	\$783.67
						
2.	1	EDI007790	000101	Storage Cabinet with Doors and Lock, 36W x 24D x 29.5H; Laminate: TBD	\$486.57	\$486.57
						
<b>Room Total:</b>						<b>\$1,270.24</b>

# Room #: Principal

					Desc: -	Qty: 10	
#	Qty		Prod#	Manufacturer	Name	Price	Ext. Price
1.	1		EDI019997	000101	10500 Single Ped Desk, Left BBF, Bow Front Top 72"W x 36"D x 29 1/2"H. Color: TBD	\$731.02	\$731.02
2.	1		EDI004338	000101	10500 Series Right Return; 48W x 24D x 29.5H; Laminate: TBD	\$459.63	\$459.63
3.	1		EDI019998	000101	Locking Stack On Storage, 72"W x 14 5/8"D x 37 1/8"H, 4 doors. Color: TBD	\$521.27	\$521.27
4.	1		EDI019641	000101	Tasklight 60W	\$90.85	\$90.85
5.	1		EDI013432	000101	Back Enclosure for Stack-on Storage for 72"W; Laminate: TBD	\$113.24	\$113.24
6.	1		EDI009935	000101	Tackboard for use with Stack-on Storage; 72"W	\$143.83	\$143.83
7.	1		EDI020000	000101	Between Round Laminate Top, 36" W. Color: TBD	\$160.07	\$160.07
8.	1		EDI020001	000101	Between Disc Base Support. Color: TBD	\$171.54	\$171.54







9.	3		EDI004284	000101	10500 Series Laminate Bookcase; 4 Shelf 36W x 13 1/8D x 57 1/8H; Laminate: TBD	\$339.24	\$1,017.72
10.	1		EDI020552	000101	Nucleus Upholstered Back Chair. Fabric: Black	\$595.19	\$595.19

---

Room Total: **\$4,004.36**

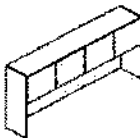

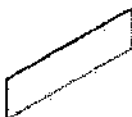

# Room #: AP & ARD Office

#	Qty	Prod#	Manufacturer	Name	Price	Ext. Price
1.	2	EDI004285	000101	10500 Series Double Pedestal Desk; 66W x 30D x 29.5H; Laminate; TBD	\$757.77	\$1,515.54
						
2.	2	EDI020002	000101	Credenza with Kneespace, file/file, 66"W x 24"D x 29 1/2"H, Color: TBD	\$706.17	\$1,412.34
						
3.	2	EDI020003	000101	Stack-On Storage, Locking. 66"W x 14 5/8"D x 37 1/8"H, 4 doors. Color: TBD	\$469.68	\$939.36
						
4.	2	EDI019641	000101	Tasklight 60W	\$90.85	\$181.70
						
5.	2	EDI007978	000101	Back Enclosure for Stack-on Storage 63 3/4"W- for 66"; Laminate: Black	\$105.60	\$211.20
						
6.	2	EDI017992	000101	Tackboards for use with Stack-on Back Enclosures; 62 3/4"W - for 66"W; Fabric: TBD	\$134.01	\$268.02
						
7.	2	EDI020022	000101	Ignition 2.0 Task Chair - Mesh Mid Back - Synchro-Tilt with seat slider - Adjustable Arms - Hard Casters - Mesh Color: Black - Fabric Seat Color: Centurion Black - Base: Standard - Base Color: Black	\$368.82	\$737.64
						





**Room Total: \$5,265.80**

# Room #: 100H AP Office

		Desc. -				Qty: 3	
#	Qty	Prod#	Manufacturer	Name	Price	Ext. Price	
1.	1	EDI015604	000101	10500 Series 3 Drawer Lateral File	\$742.71	\$742.71	
							
2.	1	EDI019743	000101	Build Half Round Tables with Adjustable Legs	\$286.75	\$286.75	
							
3.	1	EDI020022	000101	Ignition 2.0 Task Chair - Mesh Mid Back - Synchro-Tilt with seat slider - Adjustable Arms - Hard Casters - Mesh Color: Black - Fabric Seat Color: Centurion Black - Base: Standard - Base Color: Black	\$368.82	\$368.82	
							

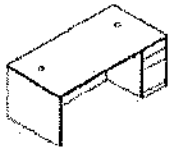

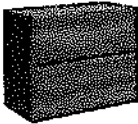



**Room Total: \$1,398.28**

# Room #: 100D Tori's Office

		Desc: -				Qty: 4	
#	Qty	Prod#	Manufacturer	Name	Price	Ext. Price	
1.	1		EDI019750	000101	10500 Series Left Pedestal Desk. 66x30x29. Color: TBD	\$587.21	\$587.21
2.	1		EDI004338	000101	10500 Series Right Return; 48W x 24D x 29.5H; Laminate: TBD	\$459.63	\$459.63
3.	1		EDI007216	000101	2 Drawer Lateral File, 36x20x29	\$402.72	\$402.72
4.	1		EDI020022	000101	Ignition 2.0 Task Chair - Mesh Mid Back - Synchro-Tilt with seat slider - Adjustable Arms - Hard Casters - Mesh Color: Black - Fabric Seat Color: Centurion Black - Base: Standard - Base Color: Black	\$368.82	\$368.82

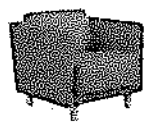

**Room Total: \$1,818.38**

# Room #: Library

					Desc: -	Qty: 6	
#	Qty	Prod#	Manufacturer	Name	Price	Ext. Price	
1.	15	EDI014299	000101	BUILD RIBBON 30 X 54	\$305.77	\$4,586.55	
							
2.	60	EDI020016	000187	18"H Thrive Contemporary polypropylene ribless flexible shell, 14 GA chrome frame. Color: Black	\$54.83	\$3,289.80	
							
3.	4	EDI007319	000101	Grove Seating Single Seat Lounge w/Straight Arms	\$808.90	\$3,235.60	
							
4.	1	EDI019744	000101	Grove 2 Seat Lounge. Color: TBD	\$1,173.28	\$1,173.28	
							
5.	4	EDI017397	000101	Skip Collaborative Chair. Poly Shell. Color Light Gray	\$367.77	\$1,471.08	
							
6.	10	EDI020553	000608	Bookmark Chair, Sled Base. Black Fabric. Finish: TBD	\$399.83	\$3,998.30	
							

**Room Total: \$17,754.61**

# Room #: Art Room

#	Qty	Prod#	Manufacturer	Name	Price	Ext. Price
1.	9	EDI010134	000167	30x60 Steel Frame Science Table	\$623.07	\$5,607.63
						
2.	30	EDI020115	000124	600 Series Industrial Stool Polypropylene Seat. 18"H, Color: TBD	\$59.86	\$1,795.80
						
<b>Room Total:</b>						<b>\$7,403.43</b>

# Room #: Cafeteria

#	Qty	Prod#	Manufacturer	Name	Price	Ext. Price
1.	24	EDI020472	000600	Mobile Bench Table - Rectangle - 30"W x 12'1"L - 4 Benches. Color: TBD.	\$1,605.80	\$38,539.20



---

Room Total: **\$38,539.20**

# Room #: Counselor Waiting Area

#	Qty	Prod#	Manufacturer	Name	Price	Ext. Price
1.	1	EDI007491	000101	Credenza with Kneespace, file/file- 60"W x 24"D x 29 1/2"H	\$689.09	\$689.09
<b>Room Total:</b>						<b>\$689.09</b>

# Room #: Teacher Work Room

#	Qty	Prod#	Manufacturer	Name	Price	Ext. Price
1.	1	EDJ020483	000167	Steel Series Table 48x84x30 - Black	\$999.02	\$999.02



Room Total: **\$999.02**



# Room #: Receptionist

#	Qty	Prod#	Manufacturer	Name	Price	Ext. Price
1.	1	EDI020551	000101	Big and Tall Mesh Back Chair. Mesh: Black Fabric: Black	\$693.33	\$693.33



Room Total: **\$693.33**

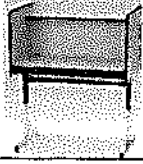

# Room #: ISS

#	Qty	Prod#	Manufacturer	Name	Price	Ext. Price
1.	10	EDI020432	000193	Single Modular Study Carrels, adjustable height T-legs, Color: Grey Nebula	\$435.47	\$4,354.70



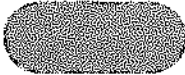

Room Total: **\$4,354.70**

# Room #: Conference Room

					Desc: -	Qty: 3	
#	Qty		Prod#	Manufacturer	Name	Price	Ext. Price
1.	8		EDI013226	000101	Pillow-Soft High-back chair, hard casters, Grd. II Whisper Vinyl - Black, Black base	\$397.31	\$3,178.48
2.	1		EDI020556	000101	Racetrack Tap 108" - 2MM Edge, No Grommet	\$591.48	\$591.48
3.	1		EDI020557	000101	Panel Base Support for 108" Table	\$294.93	\$294.93

Room Total: **\$4,064.89**

# Room #: Lobby

		Desc: -			Qty: 2	
#	Qty	Prod#	Manufacturer	Name	Price	Ext. Price
1.	2	EDI020554	000101	Grove 2 Seat Sofa. Armless, Tapered Square Legs: Silver Texture. Fabric: Silververtex Sterling	\$1,104.91	\$2,209.82
						
2.	1	EDI020555	000101	Grove 3 Seat Sofa. Armless, Tapered Square Legs: Silver Texture. Fabric: Silververtex Sterling	\$1,494.76	\$1,494.76
						

**Room Total: \$3,704.58**

## Project Summary

Qty	Room #	Description	Ext. Price
8	Classroom	- Furniture	234,341.47
4	501A Counselor	- Office	2,339.60
2	501B Counselor	- Office	1,270.24
10	Principal	-	4,004.36
7	AP & ARD Office	-	5,265.80
3	100H AP Office	-	1,398.28
4	100D Tori's	- Office	1,818.38
6	Library	-	17,754.61
2	Art Room	-	7,403.43
1	Cafeteria	-	38,539.20
1	Counselor	- Waiting Area	689.09
1	Teacher Work	- Room	999.02
1	Receptionist	-	693.33
1	ISS	-	4,354.70
3	Conference	- Room	4,064.89
2	Lobby	-	3,704.58

Product Total: **\$328,640.98**

Freight  
Installation

\*Project Total: **\$328,640.98**